

CCTV 1 CCTV 2 CCTV exhibition brand

JIETIAN SECURITY & PROTECTION LEADER



Add: No.11 Zhongwan Road, Xinglin Street, Jimei District, Xiamen City, China  
Te) : 0592-5900518 8688966  
Fax): 0592-5233088  
Website: <https://cnjietian.com/> E-mail : [info@cnjietian.com](mailto:info@cnjietian.com)



Wechat official accounts

Global service hotline  
400-6858-966

**BOLLARD | ROAD BLOCKER | TYRE KILLER**

## ORIGIN OF THE BRAND

Looking up at the ethereal starry river, the vicissitudes of the sea and the changes of the mulberry field are many masterpieces, reflecting the yearning for dreams within reach in the era of diversity. The road, not one step over, is chiseled.

Sound opens up a new shore; Fields, not enclosures, are a new foundation for breaking through the ground and searching.

"Masterpiece, Dragon and morality in the field", this is the original intention of Jietian Technology, with excellent products and services, with a grateful heart to face every customer, far away for decades, steadfast.

**Be a guardian of each road, break through the ground, and forge ahead.**

Jietian Security Protection Safety Pilot Anti-riot lifting barricade system integrated service provider.

Safety is the top priority related to people's livelihood. Guarding a territory and bringing peace and harmony to the people is what we are committed to pursuing.

Let Jietian products withstand consideration, is the direction of every Jietian unremitting efforts!

# PICC

The product liability insurance is underwritten by PICC



## CONTENTS

|                      |                             |                      |                   |
|----------------------|-----------------------------|----------------------|-------------------|
| <b>01</b>            | <b>02</b>                   | <b>03</b>            | <b>04</b>         |
| COMPANY PROFILE      | DEVELOPMENT HISTORY         | CORE COMPETITIVENESS | PRODUCT ADVANTAGE |
| <b>05</b>            | <b>06</b>                   | <b>07</b>            |                   |
| PRODUCT INTRODUCTION | PRODUCT MARKET DISTRIBUTION | PROJECT CASE         |                   |

40+

Product patent certification

20+

Computer software copyright

10000+

Successful cases

9000m<sup>2</sup>

Factory Area



## COMPANY PROFILE

Xiamen Jietian Technology Co., Ltd., founded in 2006 in the world garden city, the beautiful Egret island- Xiamen, is a national high-tech enterprise, at the beginning of its establishment adhering to the "truth-seeking, the pursuit of excellence" corporate culture, with continuous innovation of the business principle.

Establish a learning organization and technical team, introduce professional and technical personnel, create an open enterprise management model, and promote the healthy development of enterprise specialization and diversification.

Jietian Technology is a collection of lifting bollards, road blocker, tire killer and other anti-terrorist and anti-riot facilities research and development, design, production, sales and service in one of the comprehensive scientific and technological modern enterprises, now the products have taken the lead in passing GA/T1343-2016 "explosion-proof lifting resistance Car Roadblock" Ministry of Public Security type inspection report, EU CE certification, ISO9001-2015 quality management system certification, ISO14001-2015 environmental management system certification, ISO45001-2018 occupational health and safety management system certification, GB/T27922-2011 product after-sales service five-star evaluation certification, GB/T29490-2013 enterprise intellectual property management system certification and many other national authoritative quality testing; At the same time, the company has also won the "Xiamen High-tech Enterprise" and "National High-tech Enterprise" and "Xiamen Science and Technology Little Giant" Military Enterprise" and "Fujian Science and Technology Little Giant Leading Enterprise", "Xiamen Contract-abiding and Credit-worthy Enterprise", "2021 China's Top 100 Brand Influence", "China's Top Ten Lifting Column Brands" and other honorary titles.

## COMPANY CULTURE



### Culture Experience concept

Quality first, reputation first, integrity in the world



### Service concept

Customer first, attentive service



### Market purpose

Fully implement national standards and strive to pursue zero complaints



### Management philosophy

Attention to detail, focus on growth, and strive for excellence



### Quality tenet

Comprehensively improve quality standards and let the world believe in Made in China



### Enterprise spirit

Innovation, pragmatism, gratitude, win-win



# DEVELOPMENT HISTORY 发展历程

SINCE 2006

ENTERPRISE ALBUM 2023

JIETIAN TECHNOLOGY

**June 2006**  
Xiamen Jietian Technology Co., Ltd.  
Formally established

**In October 2010**  
we obtained ISO9001 products  
Quality management system  
certification

**In July 2012**  
it obtained ISO 14001-2015 environmental  
management system certification

**In August 2016**  
the new integrated lifting bollard;  
Road blocker; tire killer was obtained  
three utility model patents.

**In December 2017**  
it obtained the comprehensive  
monitoring and control of lifting bollards  
Three software copyrights and China Lift  
Bollards top ten brand honorary title

**In January 2018**  
I obtained ISO45001-2018 Chinese Occupation  
Health and safety management system certification

**In November 2018**  
Jietian lifting bollard passed GA/T1343-2016  
"Explosion-proof lifting Roadblock" Ministry  
of Public Security Type inspection report

**2019-2022 degree  
Xiamen City**  
Contract-abiding and credit-worthy  
enterprises

**In July 2019**  
it obtained GB/T 27922-2011 products  
After-sales service five-star  
evaluation certification

**May 2021**  
won the 2021 China Brand Top  
100 influential enterprises

**In July 2020**  
it won the Fujian Small Giant  
Enterprise of Science and Technology

**August 2020**  
won GB/T29490-2013 enterprise  
knowledge Property rights management  
system certification

**In December 2020**  
it was awarded the national  
high-tech enterprise

**March 2023**  
won the innovative small and  
medium-sized enterprise

**In July 2023**  
Jietian signed a contract with  
PICC products Liability insurance  
underwriting enterprises

**In March 2022**  
Got three sections pneumatic lifting bollards and  
others, total three  
Utility model patents and five software works  
monopolize.



# 2021 | 中国品牌影响力 (第八届) | 评价成果发布

## 厦门杰田科技有限公司、徐细龙董事长再创佳绩荣获两项大奖!

2021 The 8th China Brand Influence Evaluation Results Release Xiamen Jietian Technology Co., Ltd. and Chairman Xu Xilong won two more awards!



十二届全国政协副主席齐续春与出席2021 (第八届) 中国品牌影响力评价成果发布活动全体嘉宾合影留念

The 2021 (8th) China Brand Influence Evaluation Results were jointly organized by China Enterprise News Group, the Special Publication Department of Consumer Daily, the "Discover Brand" column group, the "Market News Online Edition" brand power and independent brand selection demonstration project under People's Daily, the China International Brand Strategy Research Center of the University of International Business and Economics, and the Beijing Brand Association, Xiamen Jietian Technology Co., Ltd. won the "2021 China Top 100 Brand Influence" award, and Chairman Xu Xilong won the "2021" China Brand Influence Top Ten Innovative Entrepreneurs" award, the award fully affirmed the achievements of the "Jietian" brand in recent years.

With 15 years of product strength, continuous innovation and product sales network throughout the country, Xiamen Jietian Technology has served more than 100,000 customers and exported to Italy, Britain, Germany, Japan and other parts of the world, enjoying a high reputation and influence to win this award, which is well deserved.

# CORE COMPETITIVENESS 荣誉资质

Jietian along the way, focus on security, persistent quality, consistent! The so-called Jietian spirit is customer first, the pursuit of excellence, more excellence! Every Jietian stuffs will take this spirit as a firm tenet of life! Because of this, it has created a brilliant project and won a medal of honor.



# PRODUCT ADVANTAGE

## The pneumatic lifting bollard successfully passed the A-class crash test of the Ministry of Public Security

Jietian pneumatic lifting bollard and hydraulic lifting bollard have successfully passed the inspection of the Ministry of Public Security; After the 6.8-ton truck crashed at a speed of 80km/h in real vehicle, the relevant staff of the Ministry of Public Security tested the distance of the truck, the interception effect and the bollards of Jietian after the truck hit. The damage to the descending column was fully tested. In addition to the normal wear of the column body surface and reflective sticker after impact, the column body has no tilt, no depression, no damage to the overall structure, and can be lifted normally.

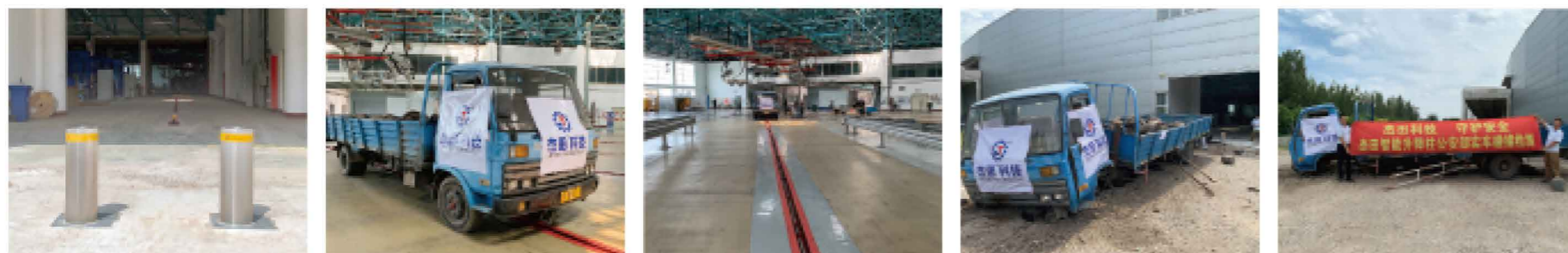

The 6.8-ton truck was tested at a real vehicle crash at a speed of 80km/h

## The hydraulic lifting bollard successfully passed the Class B crash test of the Ministry of Public Security

The Ministry of Public Security of the People's Republic of China issued the People's Republic of China public safety industry standard GA/T1343-2016, this standard is drafted in accordance with the rules given in GB/T1.1-2009, this standard is proposed by the National Police Equipment Standardization Technical Committee (SAC/TC561) and centralized, this standard drafting unit: Ministry of Public Security Special Police Equipment Quality Supervision and Inspection Center.



Professional R & D design PLC control programming, stable performance, strong anti-interference, can be linked with mobile phone APP and computer remote control, Firefighting, public security barrier and license plate recognition system docking lifting function.

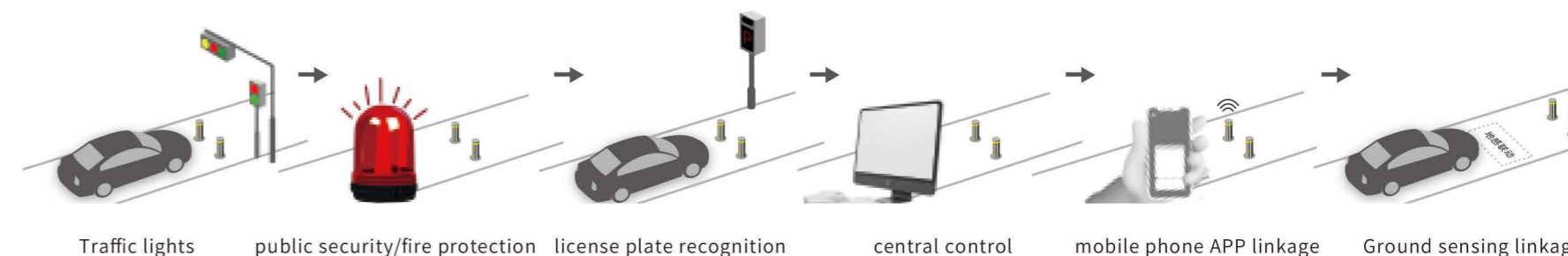

The lifting column body is uniformly made of 304# stainless steel seamless pipe, which is anti-corrosion above grade 7, eliminating rust and improving product service life.





The products have taken the lead in passing GA/T 1343-2016 "Explosion-proof Lifting Barrier Roadblock" Ministry of Public Security Type Inspection Report, EU CE Certification, ISO9001-2015 Quality Management System Certification, ISO 14001-2015 Environmental Management System Certification, ISO 45001-2018 China Occupational Health and Safety Management System Certification, GB/T 27922-2011 Commodity After-sales Service Five-Star Evaluation Certification, GB/T29490-2013 Enterprise intellectual property management system certification and many other national authoritative quality testing, using miniature water-immersion motor design, dustproof and waterproof grade standard of the highest level.



using miniature water-immersion motor design, dustproof and waterproof grade standard of the highest level.

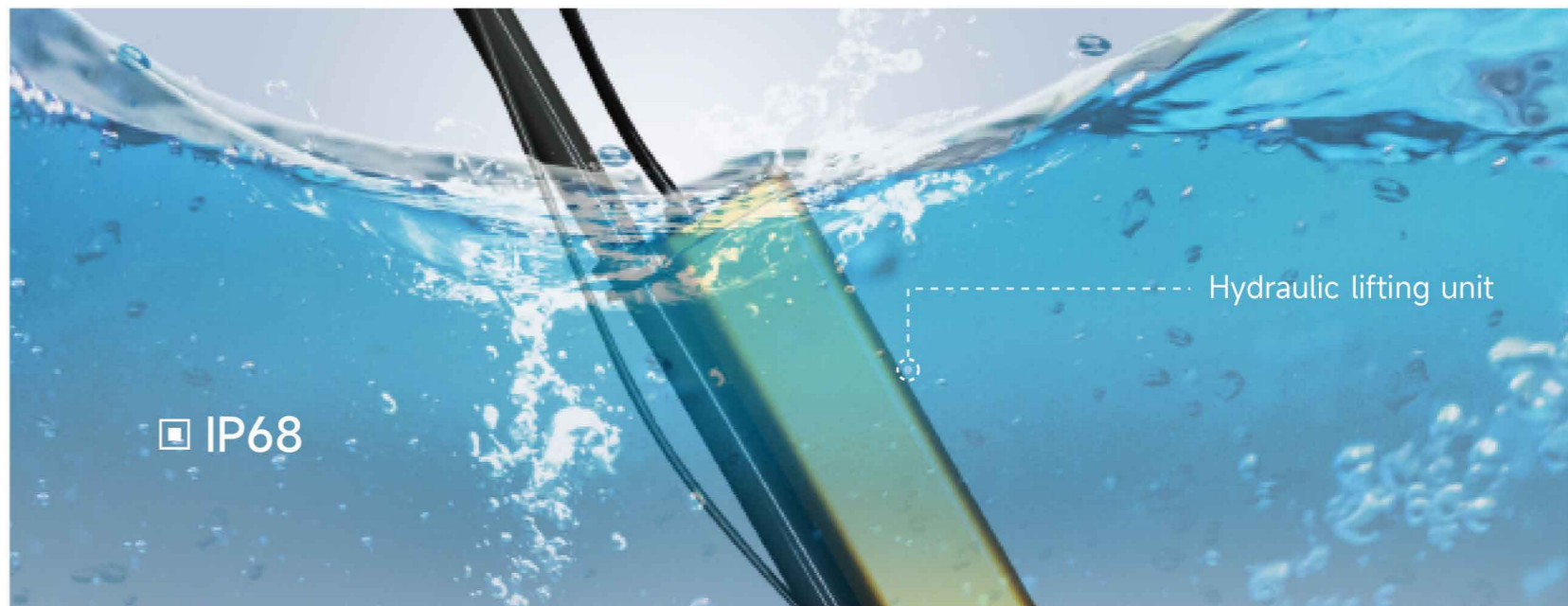

# HYDRAULIC BOLLARDS

The internal structure of the automatic hydraulic lifting bollard is made of stainless steel, and the barrel is pre-embedded, it is a hot-dip galvanized seamless pipe, the surface electrostatic powder spraying has strong corrosion resistance, and the lifting device is electromechanical, liquid integrated design, driven by a hydraulic system with PLC to control the rise and fall of the moving cylinder, fast speed and stable operation. The intelligent control system can implement a variety of optional functions as well, it can linkage with computer to realize remote central control, mobile phone APP control, complete functions, can be stable.

Optional components include: ultra-bright LED warning lights, equipment status display, vehicle detection device, backup power relief module, automatic detection heating device, etc.

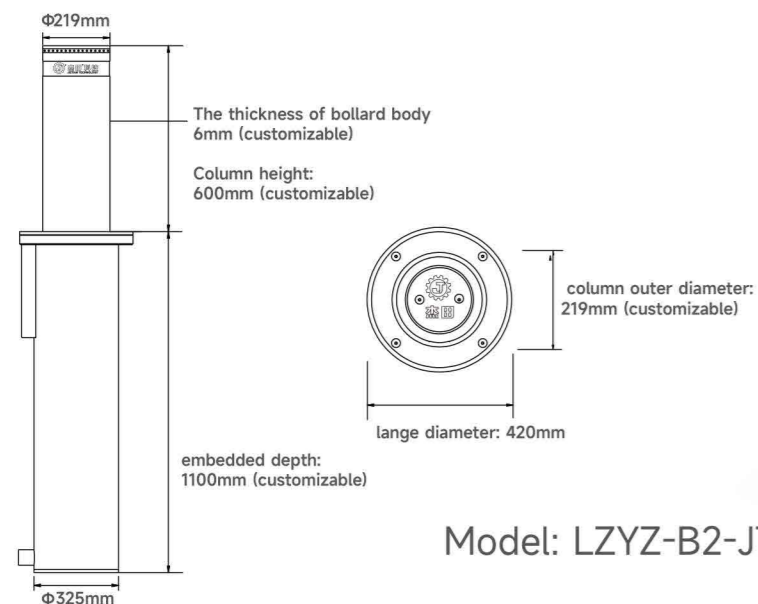

Section B

Model: LZYZ-B2-JT01B



### 10mm thick 304# stainless steel cylinder cover plate

10mm thick stainless steel cylinder cover plate ensures strong pressure resistance, CNC lathe turning end face technology, good finish, resistance, corrosion, high and low temperature resistance, the surface adopts a unique anti-slip design,



### Cylinder body is 304# stainless steel seamless steel pipe.

304# stainless steel seamless steel pipe, cylinder adopts CNC lathe processing, good roundness and finish, good plastic extension strength, high tensile strength, strong impact resistance, and the surface adopts wire drawing treatment, beautiful appearance, corrosion resistance, high and low temperature resistance, long service life.



### License plate recognition linkage and remote control

It can be linked with warning lights, access control systems, license plate recognition, ground sensor coils, traffic lights, alarm systems, infrared security, light sensing, Bluetooth, radio frequency (RFID) remote control (TCP/IP), etc. Can access the Internet remote control operation.



### Pre-embedded convenient drainage system

installation of lifting column while pre-embedded drainage system, can effectively solve the high ground-water level or low terrain easy to cause water accumulation areas, well ensure the performance and service life of the lifting column.



### Ultra-resistant to high and low temperatures

The lifting column can work normally in the environment of  $-40^{\circ}\text{C} \sim 70^{\circ}\text{C}$ , and the optional constant temperature system can meet various harsh rings



### Hydraulic lifting column movement drive

The lifting column integrated movement dustproof and waterproof protection grade IP68, after a longtime flooding testing, immersion in water can work normally.

# HYDRAULIC LIFTING COLUMN MOVEMENT DRIVE

### Dustproof and waterproof protection grade IP68

Lifting column integrated movement dustproof and waterproof protection grade IP68, after a longtime flooding testing, immersion in water can work normally.

### High speed + buffering

Its lifting speed can reach 300mm/s; When descending, a specially designed hydraulic shock absorber is built into the bottom of the cylinder, which greatly reduces the bottom impact without affecting the lifting speed.

### Emergency lifting and lowering of power failure

In case of sudden situations such as power failure, manual ascending or lowering operations can be carried out through manual emergency equipment

### Ultra-resistant to high and low temperatures

The lifting column can work normally in the  $-40^{\circ}\text{C} \sim 70^{\circ}\text{C}$  environment, and the optional constant temperature system can meet the needs of various harsh environments.

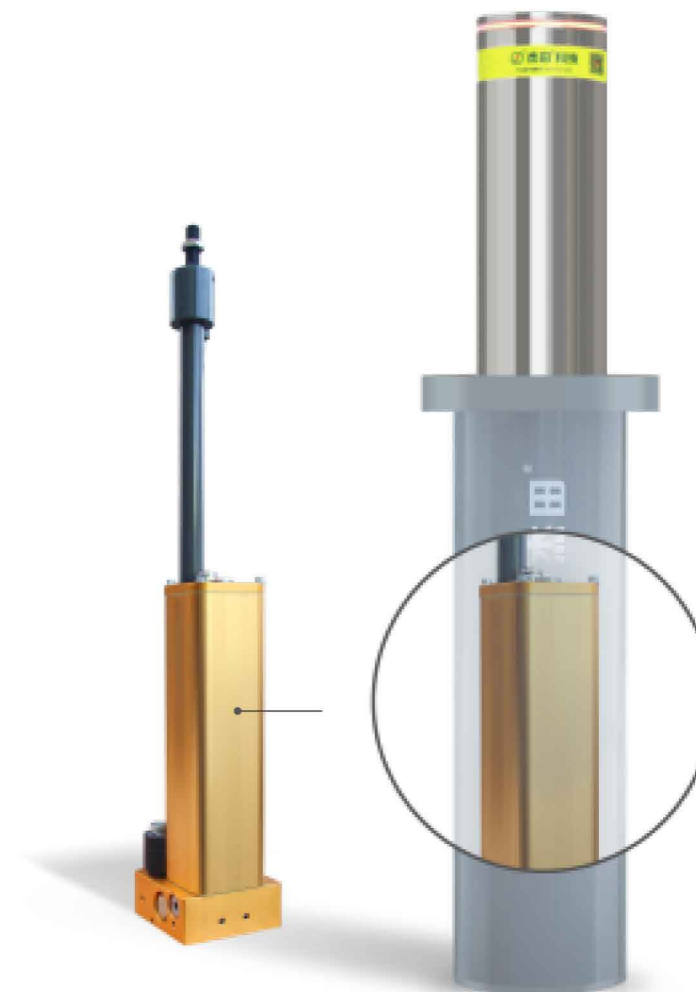

Model: JT-YTS-01

技术参数: Technical Parameters

|                   |             |                        |           |
|-------------------|-------------|------------------------|-----------|
| Model             | JT-YTS-01   | Work itinerary         | 610mm±imm |
| Operating voltage | AC220V/50HZ | Working speed          | 2-45      |
| Motor power       | 320W        | Emergency drop voltage | DC12V     |



# HYDRAULIC LIFTING COLUMN PRODUCT PARAMETER COMPARISON TABLE



| Model: JT-SJZ-217-A                                                              | Model: LZYZ-B2-JT01B                                                             | Model: LZYZ-B2-JT02B                                                             | Model: LZYZ-A3-JT273A                                                            | Model: LZYZ-A3-JT273A                                                            | Model: JT-SJZ-168A                                                               |
|----------------------------------------------------------------------------------|----------------------------------------------------------------------------------|----------------------------------------------------------------------------------|----------------------------------------------------------------------------------|----------------------------------------------------------------------------------|----------------------------------------------------------------------------------|
| Column height: 600mm(can be customized)                                          | Column height: 600mm(can be customized)                                          | Column height: 600mm(can be customized)                                          | Column height: 600mm(can be customized)                                          | Column height: 600mm(can be customized)                                          | Column height: 600mm(can be customized)                                          |
| Cylinder diameter: 219mm(can be customized)                                      | Cylinder diameter: 219mm(can be customized)                                      | Cylinder diameter: 219mm(can be customized)                                      | Cylinder diameter: 273mm(can be customized)                                      | Cylinder diameter: 273mm(can be customized)                                      | Cylinder diameter: 168mm(can be customized)                                      |
| Column thickness: 6mm (can be customized)                                        | Column thickness: 8mm (can be customized)                                        | Column thickness: 6mm (can be customized)                                        | Column thickness: 10mm (can be customized)                                       | Column thickness: 10mm (can be customized)                                       | Column thickness: 6mm (can be customized)                                        |
| Column material: 304# stainless steel seamless steel pipe                        | Column material: 304# stainless steel seamless steel pipe                        | Column material: 304# stainless steel seamless steel pipe                        | Column material: 304# stainless steel seamless steel pipe                        | Column material: 304# stainless steel seamless steel pipe                        | Column material: 304# stainless steel seamless steel pipe                        |
| Diameter of embedded barrel: Φ273mm                                              | Diameter of embedded barrel: Φ325mm                                              | Diameter of embedded barrel: Φ325mm                                              | Diameter of embedded barrel: Φ325mm                                              | Diameter of embedded barrel: Φ377mm                                              | 预埋桶直径: Φ273mm                                                                    |
| Height of embedded barrel: 1100mm Thickness: 3.0mm                               | Height of embedded barrel: 1100mm Thickness: 4.0mm                               | Height of embedded barrel: 800mm Thickness: 4.0mm                                | Height of embedded barrel: 1100mm Thickness: 4.0mm                               | Height of embedded barrel: 800mm Thickness: 4.0mm                                | Height of embedded barrel: 1100mm Thickness: 3.0mm                               |
| Lifting time: 2-4 seconds                                                        | Lifting time: 2-4 seconds                                                        | Lifting time: 2-4 seconds                                                        | Lifting time: 2-4 seconds                                                        | Lifting time: 2-4 seconds                                                        | Lifting time: 2-4 seconds                                                        |
| Power: 320W                                                                      | Power: 320W                                                                      | Power: 320W                                                                      | Power: 320W                                                                      | Power: 320W                                                                      | Power: 320W                                                                      |
| Protection class: IP68                                                           | Protection class: IP68                                                           | Protection class: IP68                                                           | Protection class: IP68                                                           | Protection class: IP68                                                           | Protection class: IP68                                                           |
| Working temperature: -30°C ~ 55°C                                                | Working temperature: -30°C ~ 55°C                                                | Working temperature: -30°C ~ 55°C                                                | Working temperature: -30°C ~ 55°C                                                | Working temperature: -30°C ~ 55°C                                                | Working temperature: -30°C ~ 55°C                                                |
| Drive voltage: AC380V, AC220V, DC24V                                             | Drive voltage: AC380V, AC220V, DC24V                                             | Drive voltage: AC380V, AC220V, DC24V                                             | Drive voltage: AC380V, AC220V, DC24V                                             | Drive voltage: AC380V, AC220V, DC24V                                             | Drive voltage: AC380V, AC220V, DC24V                                             |
| Warning signs: ultra-bright LED light and 3M reflective film                     | Warning signs: ultra-bright LED light and 3M reflective film                     | Warning signs: ultra-bright LED light and 3M reflective film                     | Warning signs: ultra-bright LED light and 3M reflective film                     | Warning signs: ultra-bright LED light and 3M reflective film                     | Warning signs: ultra-bright LED light and 3M reflective film                     |
| Control mode: PLC control system, wired desktop control, wireless remote control | Control mode: PLC control system, wired desktop control, wireless remote control | Control mode: PLC control system, wired desktop control, wireless remote control | Control mode: PLC control system, wired desktop control, wireless remote control | Control mode: PLC control system, wired desktop control, wireless remote control | Control mode: PLC control system, wired desktop control, wireless remote control |
| Emergency function: equipped with EPS emergency power supply and one-key descent | Emergency function: equipped with EPS emergency power supply and one-key descent | Emergency function: equipped with EPS emergency power supply and one-key descent | Emergency function: equipped with EPS emergency power supply and one-key descent | Emergency function: equipped with EPS emergency power supply and one-key descent | Emergency function: equipped with EPS emergency power supply and one-key descent |

SINCE 2006

ENTERPRISE ALBUM 2023

JIETIAN TECHNOLOGY

# CONTROL SYSTEM

Hydraulic lifting bollard intelligent control system



The internal layout is standardized, reasonable and beautiful; Electrical components are purchased from first-line high-quality brands.

技术参数: Technical Parameters

|                             |                                                                |
|-----------------------------|----------------------------------------------------------------|
| Input voltage               | Single-phase 220VAC/three-phase 380VAC                         |
| Output voltage              | Single-phase 220VAC/three-phase 380VAC                         |
| Installation method         | Floor-to-ceiling / wall-mounted indoor/ outdoor                |
| Degree of protection        | IP54                                                           |
| Material                    | Galvanized sheet                                               |
| Control mode                | Remote control/mobile APP/remote control/other linkage devices |
| Control the motherboard     | PLC                                                            |
| Mode of transmission        | 4G/5G/WIFI/LAN/WAN                                             |
| Backup battery              | accumulator                                                    |
| Public security linkage     | Support                                                        |
| Power outage emergency drop | Support                                                        |
| Remote control              | Support                                                        |
| buzzer                      | Support                                                        |
| traffic light               | Support                                                        |
| Ground sense linkage        | Support                                                        |
| License plate recognition   | Support                                                        |

## Remote control



Technical Parameters

- Control mode: wireless remote control, 315 MHz encryption
- Control distance: ≥50m empty
- Control actions: Control the rise, down, and stop switches
- Control actions: Using frequency modulation, anti-interference, encryptorEnsure the security of the transmission signal

## Wired console

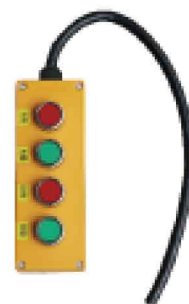

Technical Parameters

- Control mode: Line empty
- Control distance: ≥200m
- Control actions: Control the rise, down, and stop switches

# SCHEMATIC DIAGRAM OF HYDRAULIC LIFTING COLUMN INSTALLATION

Installation requirements: Recommended distance between the center of the lifting column and the center of the lifting column is 800-1200mm (customized)  
Embedded depth according to the product 1100-800mm(customized)

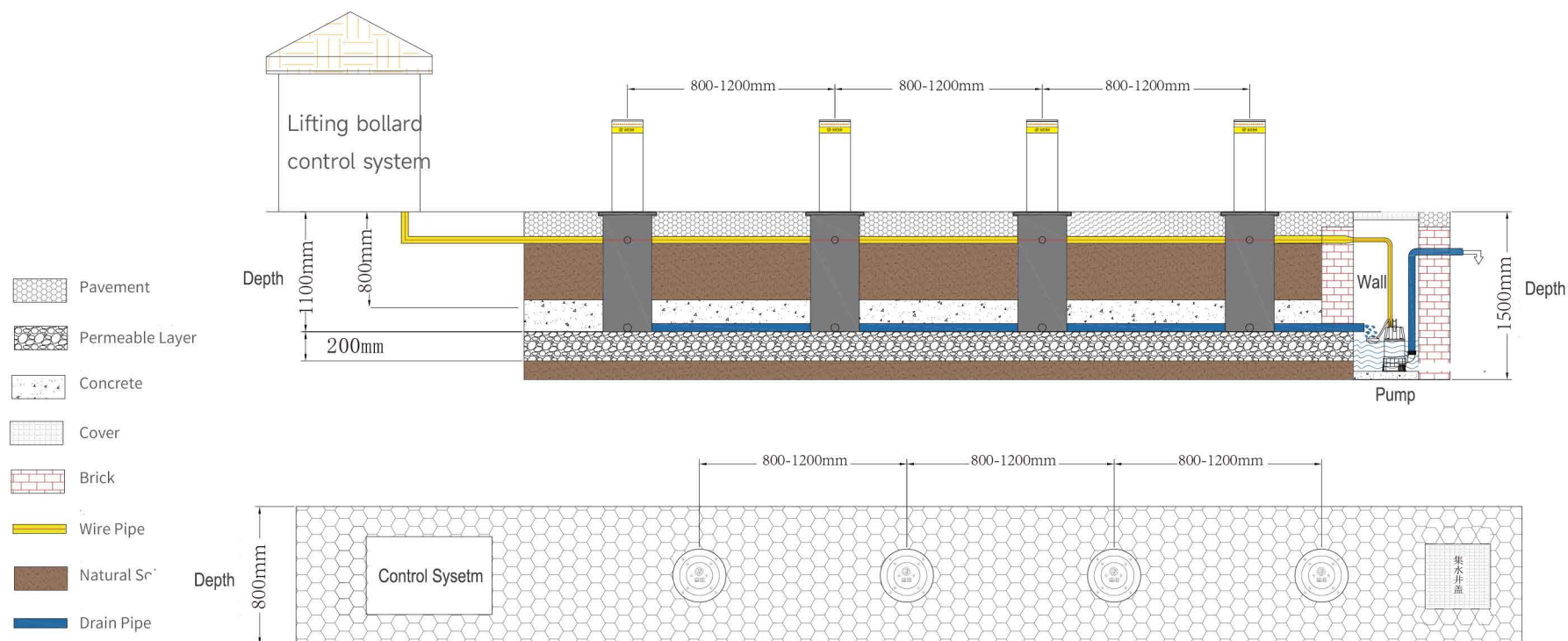

# SEMI-AUTOMATIC BOLLARDS

Semi-automatic lifting bollard, the rise is driven by the built-in gas spring, and the descent is manually assisted, which is widely used in the entrances and exits of vehicle passages with infrequent traffic (such as: fire escapes, parks, pedestrian streets, etc.). It is composed of cylinder, flange, lifting guide system, gas spring, hexagon lock structure, etc.

At the same time, it is more economical, stable, safe, practical and reliable to use with the same shape of automatic lifting column, and can save costs.

Model: JT-SJZ-217B

## Operation diagram: ascending process/descending process

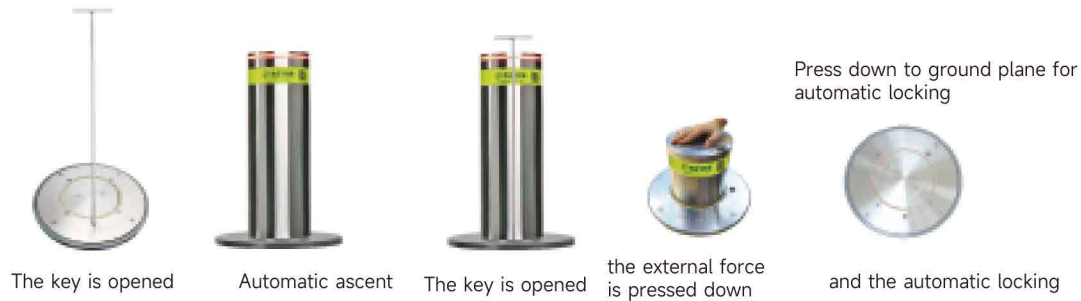

Rise: Turn the key, the cylinder automatically rises, and automatically locks in the limited position.

Fall: Turn the key, apply pressure on the top of the cylinder, and the cylinder will drop back to ground level to automatically lock.

| Product Technical Parameters                                                           |                                                              |
|----------------------------------------------------------------------------------------|--------------------------------------------------------------|
| Column height: 600mm(can be customized)                                                | Embedded barrel diameter: Φ325mm                             |
| Cylinder diameter: 219mm(can be customized)                                            | Embedded barrel height: 800mm Thickness: 3.0mm               |
| Column thickness: 6mm (can be customized)                                              | Protection class: IP68                                       |
| Cylinder material: 304# stainless steel seamless steel pipe                            | Working temperature: -30°C ~ 55°C                            |
| Passing Pressure : ≥80T                                                                | Drive system: gas spring drive                               |
| Anti-corrosion treatment: hot-dip galvanized + zinc-infiltrated baking paint treatment | Warning signs: ultra-bright LED light and 3M reflective film |

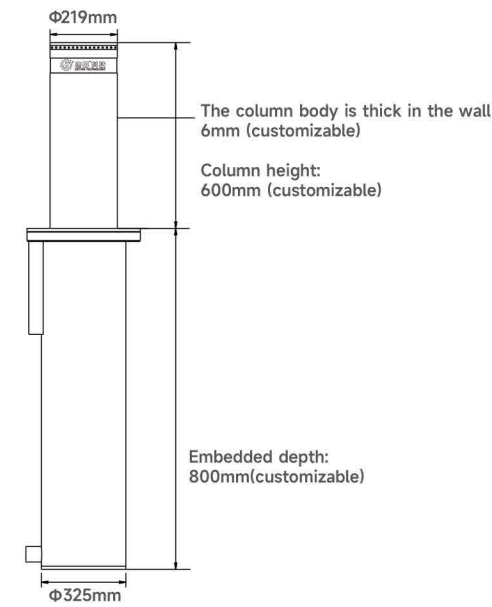
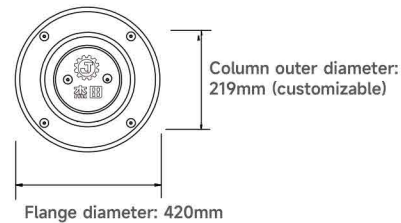

**Ultra-bright LED warning light**  
 he top adopts ultra-bright LED warning lamp beads, 360 degrees embedded in the PC light tray, ultra-long service life, light transmission, good waterproof, good flexibility, wear resistance, scratch resistance, impact resistance, washing resistance. DC12V low voltage, energy saving, environmental protection. After the column is lowered, the light is hidden, the ground warning halo can be observed at night,

**3M diamond grade reflective warning film,**  
 unique micro-prism technology design, with super reflective performance, good wide angle, good weather resistance, performance as usual under -40 °C ~ 70 °C conditions, wear and scratch resistance, impact resistance, good toughness.

**Cylinder body 304# stainless steel seamless steel pipe**  
 304# stainless steel seamless steel pipe cylinder adopts CNC lathe processing, good roundness and finish, good plastic extension strength, high tensile strength, strong impact resistance, and the surface adopts wire drawing treatment, beautiful appearance, corrosion resistance, high and low temperature resistance, long service life.

**10mm thick flange cover**  
 10mm thick 304# stainless steel flange cover plate to ensure that the column body has strong pressure resistance, CNC lathe technology, and the column body is in good shape, while the finish is good, corrosion resistance, high and low temperature resistance, and the surface adopts a unique anti-skid design.

**Pre-embedded convenient drainage system**  
 The installation of the lifting column while pre-embedding the drainage system can effectively solve the area where the groundwater level is high or the terrain is low and it is easy to cause water, and ensure the performance and service life of the lifting column.

## REMOVABLE BOLLARDS



|                                                                                                                                                                                                                                                                                                                    |
|--------------------------------------------------------------------------------------------------------------------------------------------------------------------------------------------------------------------------------------------------------------------------------------------------------------------|
| <b>Model: JT-YDZ-01</b>                                                                                                                                                                                                                                                                                            |
| Column height: 600mm(customized)                                                                                                                                                                                                                                                                                   |
| Cylinder diameter: 219mm (customized)                                                                                                                                                                                                                                                                              |
| Column thickness: 6mm (customized)                                                                                                                                                                                                                                                                                 |
| Column material: 304# stainless steel seamless steel pipe                                                                                                                                                                                                                                                          |
| Working voltage: 12v                                                                                                                                                                                                                                                                                               |
| Control mode: detachable, removable                                                                                                                                                                                                                                                                                |
| Working temperature: -30°C-55°C                                                                                                                                                                                                                                                                                    |
| Warning signs: ultra-bright LED light and 3M reflective film                                                                                                                                                                                                                                                       |
| The mobile column adopts detachable mobile structure design, which is convenient to operate and simple to manage, and is suitable for inlet and fire escape openings that are not commonly used. At the same time, it can be used with automatic lifting column, semi-automatic lifting column, fixed column, etc. |

## FIXED BOLLARDS



|                                                                                                                                                                                                                                                                                                                                                                                                                                           |
|-------------------------------------------------------------------------------------------------------------------------------------------------------------------------------------------------------------------------------------------------------------------------------------------------------------------------------------------------------------------------------------------------------------------------------------------|
| <b>Model: JT-GDZ-02</b>                                                                                                                                                                                                                                                                                                                                                                                                                   |
| Column height: 600mm(customized)                                                                                                                                                                                                                                                                                                                                                                                                          |
| Cylinder diameter: 219mm (customized)                                                                                                                                                                                                                                                                                                                                                                                                     |
| Column thickness: 8mm (customized)                                                                                                                                                                                                                                                                                                                                                                                                        |
| Column material: 304# stainless steel seamless steel pipe                                                                                                                                                                                                                                                                                                                                                                                 |
| 工作电压: 12V                                                                                                                                                                                                                                                                                                                                                                                                                                 |
| Impact resistance: Withstands ≥ 15,000J                                                                                                                                                                                                                                                                                                                                                                                                   |
| Working temperature: -30°C-55°C                                                                                                                                                                                                                                                                                                                                                                                                           |
| Warning signs: ultra-bright LED light and 3M reflective film                                                                                                                                                                                                                                                                                                                                                                              |
| Fixed columns are mainly installed in enclosed areas, which are most suitable for permanent vehicle control without obstructing pedestrians, providing specific facilities and landscape protection, and can ensure vision while improving the arch openness of the place. At the same time, it can be used with automatic lifting column, semi-automatic lifting column, mobile column, etc. according to the actual needs of customers. |



## SEMI-AUTOMATIC LIFTING COLUMN/MOVING COLUMN/FIXED COLUMN INSTALLATION SCHEMATIC

Installation requirements: Recommended distance between the center of the lifting column and the center of the lifting column is 800-1200mm (can also be customized according to customer needs)

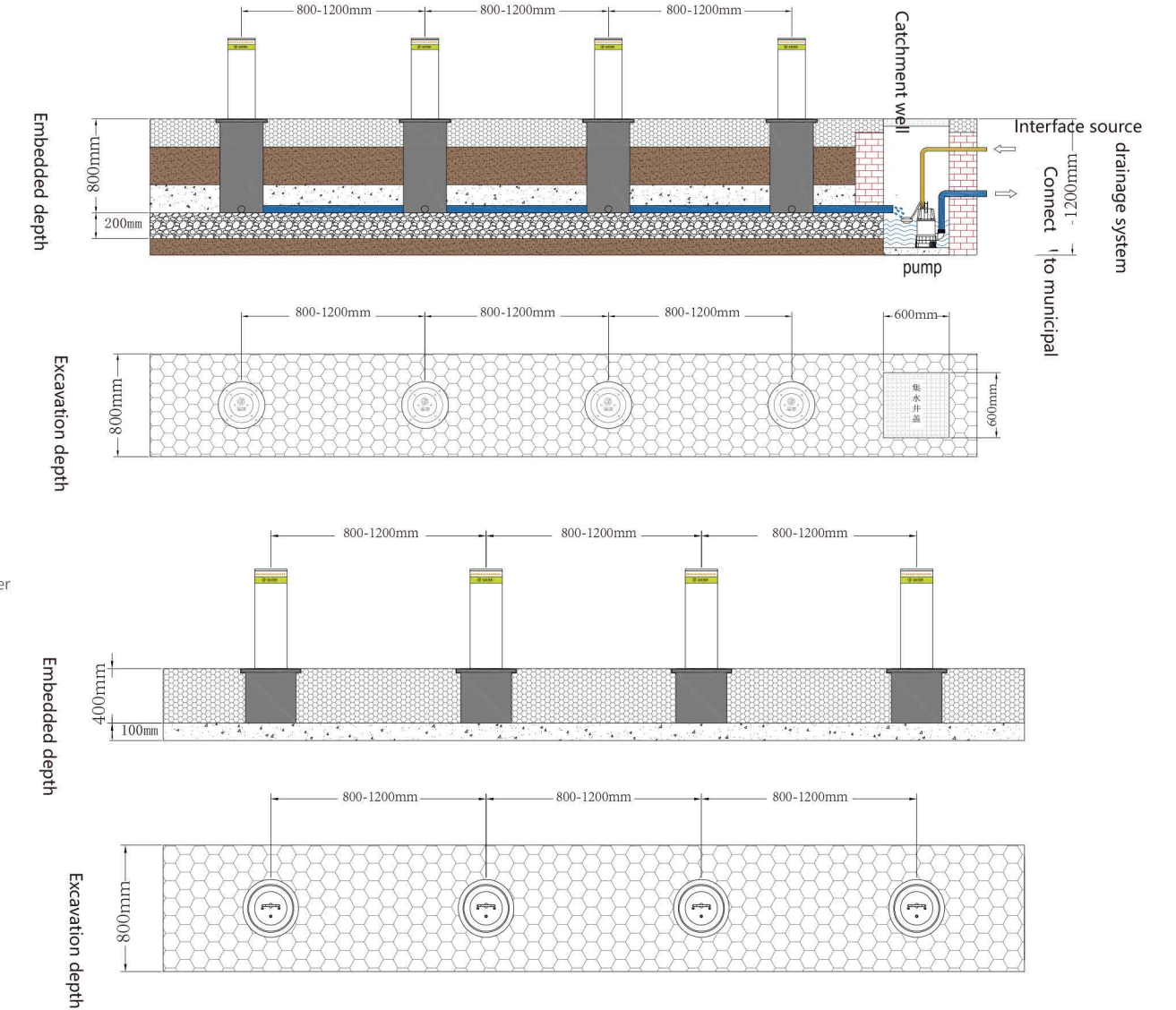

# PNEUMATIC BOLLARDS

The pneumatic lifting bollard uses compressed air as the driving medium, and the system is mainly composed of air pump station, cylinder, solenoid valve, etc. Compared with hydraulic and electric lifting columns, pneumatic lifting columns have the characteristics of superior running performance, environmental protection and durability, low maintenance costs and strong driving force.

The pneumatic lifting column is usually installed at the gate of each unit, the entrance and exit of motor vehicles and the control point, and the PLC is used to control the rise and fall of the active column, with fast speed and stable operation. The intelligent control system can not only realize a variety of optional functions, but also can be linked with the computer to realize remote operation. Central control, mobile APP control, complete functions, stable performance. Optional components include: ultra-bright LED warning lights, equipment status display devices, vehicle detection devices, automatic detection heating devices, etc.

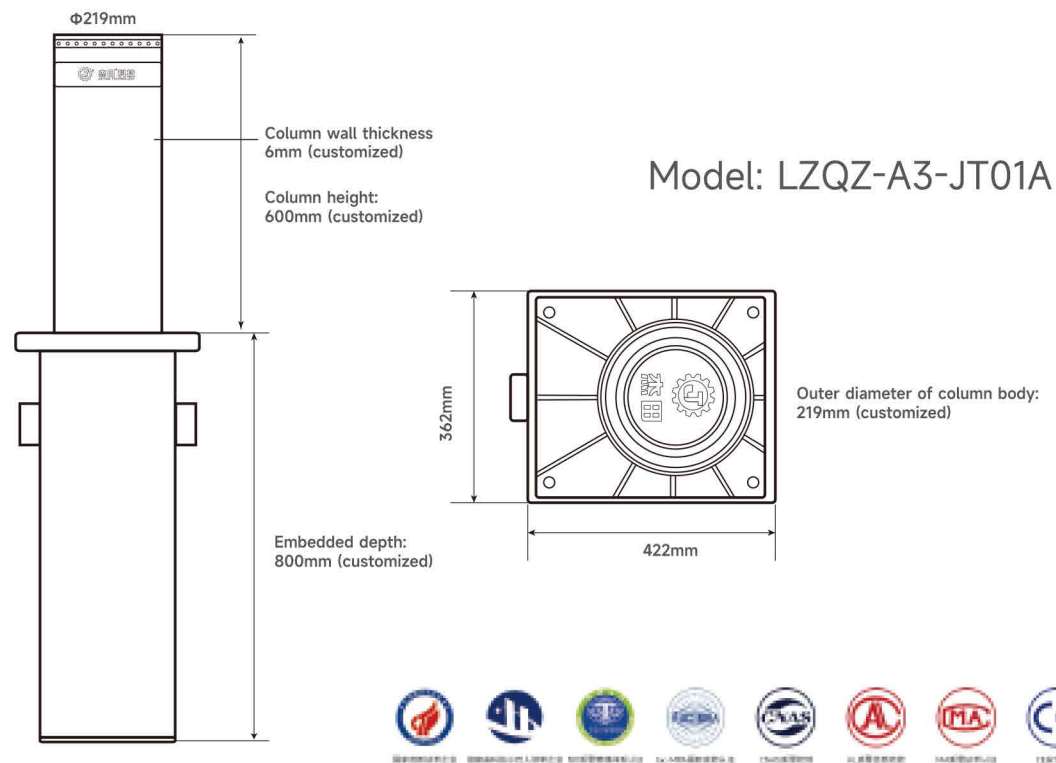

### 10mm thick 304# stainless steel cylinder cover plate

10mm thick stainless steel column cover plate to ensure strong pressure resistance, CNC lathe turning end face technology, good finish, corrosion resistance, high and low temperature resistance, the surface adopts unique anti-skid design cylinder 304# stainless steel seamless steel pipe



### Cylinder body 304# stainless steel seamless steel pipe

304# stainless steel seamless steel pipe cylinder adopts CNC lathe processing, good roundness and finish, good plastic extension strength, high tensile strength, strong impact resistance, and the surface adopts wire drawing treatment, beautiful appearance, corrosion resistance, high and low temperature resistance, long service life.



### License plate recognition linkage and remote control

It can be linked with warning lights, access control systems, license plate recognition, ground induction coils, traffic lights, alarm systems, infrared security light sensing, Bluetooth, radio frequency (RFID) remote control (TCP/IP), etc. Can access the Internet remote control operation.



### Pre-embedded convenient drainage system

The installation of the lifting column while pre-embedding the drainage system can effectively solve the area where the groundwater level is high or the terrain is low and it is easy to cause water, and ensure the performance and service life of the lifting column.



### Ultra-resistant to high and low temperatures

The lifting column can work normally in the -40°C~70°C environment, and the optional constant temperature system can meet the needs of various harsh environments.



### Dustproof and waterproof protection grade IP68

The lifting column integrated movement dustproof and waterproof protection grade IP68, after a longtime soaking test, immersion water can work normally.



# PNEUMATIC MOVEMENT STARTER

## Evolution again, born for the future

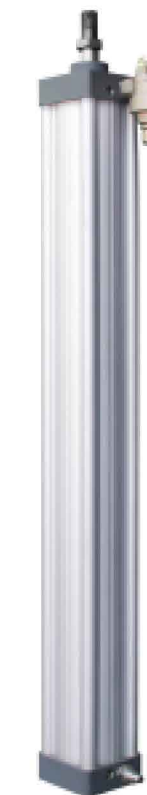

- Strong driving force**  
 lifting column rise and fall are all driven by compressed air, the lifting speed is very fast, 1min time can rise, can be used frequently, with real anti-terrorism significance.
- Simple maintenance**  
 The execution output of pneumatic components is smaller than hydraulic pressure, faster movement, strong adaptability, can work in harsh environments, long working life, removable structure, easy maintenance, low maintenance cost
- The structure is more solid**  
 the structure is strong and durable, the bearing load is large, the action is stable, the noise is low, the speed is fast, and the life is long.
- Eco-friendly and durable**  
 The pneumatic system has strong adaptability to the environment, can work reliably in a wide temperature range, humid and dusty environment, and uses air pressure as a power energy, which is environmentally friendly and safe.

## TWO-STAGE PNEUMATIC BOLLARDS

The double-stage pneumatic lifting column is a product developed and customized for places that cannot meet the excavation depth, only need to excavate 470mm to complete the installation, the excavation depth is less than half of similar products, very suitable for underground parking lots, underground pipelines complex and unable to excavate depth.



Ultra-shallow Embedment Easy installation Innovative design Easy maintenance

Model: LZQZ-D1-JT02

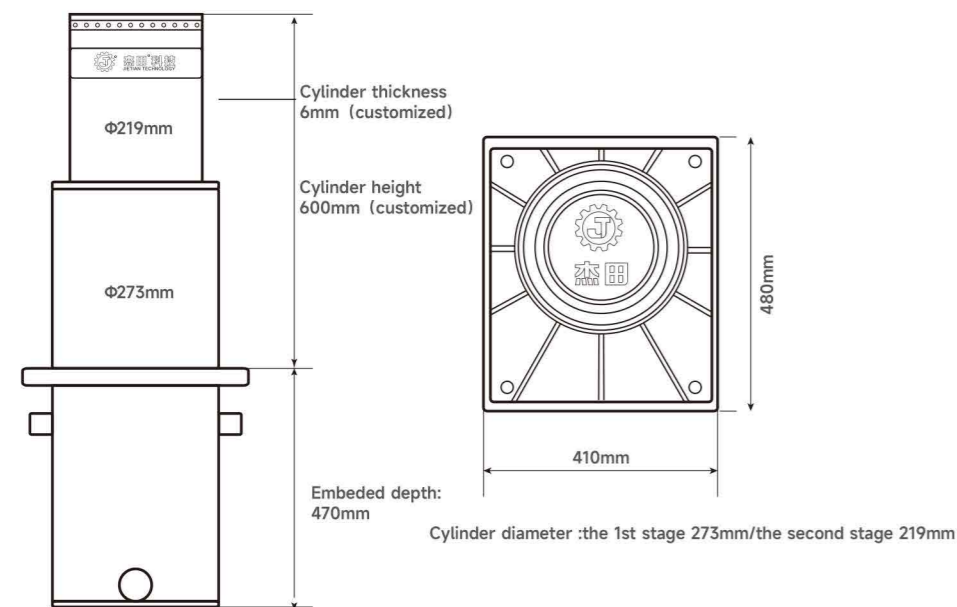

Embeded depth:  
470mm



Embeded depth:  
400mm

Model: LZQZ-D1-JT03

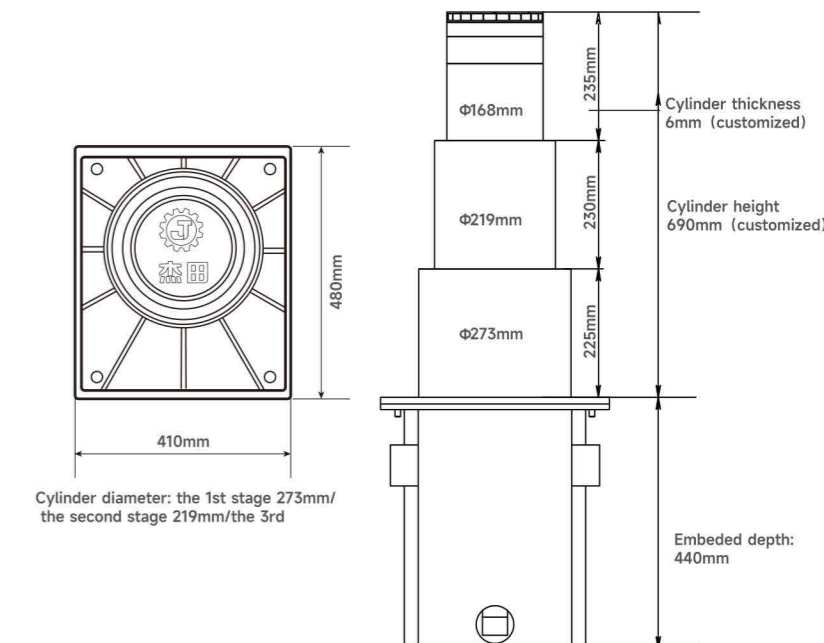

# Pneumatic lifting bollard product parameter comparison table



| Model: LZQZ-A3-JT01A                                                             |
|----------------------------------------------------------------------------------|
| Column height: 600mm(can be customized)                                          |
| Cylinder diameter: : 219mm(can be customized)                                    |
| Column thickness: 10mm (can be customized)                                       |
| Column material: 304# stainless steel seamless steel pipe                        |
| Ground flange: 304# stainless steel, thickness: 12.0mm                           |
| Buried barrel height:800mm Thickness: 6.0mm                                      |
| Lifting time: ≤3 seconds (adjustable fast 1 second)                              |
| Drive mode: compressed air drive                                                 |
| Protection class: IP68                                                           |
| Working temperature: -30°C ~ 55°C                                                |
| Drive voltage: DC24V                                                             |
| Warning signs: ultra-bright LED light and 3M reflective film                     |
| Control mode: PLC control system, wired desktop control, wireless remote control |
| Emergency function: equipped with EPS emergency power supply and one-key descent |



| Model: LZQZ-B1-JT01                                                              |
|----------------------------------------------------------------------------------|
| Column height: 600mm(can be customized)                                          |
| Cylinder diameter: : 219mm(can be customized)                                    |
| Column thickness: 6mm (can be customized)                                        |
| Column material: 304# stainless steel seamless steel pipe                        |
| Ground flange: 304# stainless steel, thickness: 12.0mm                           |
| Buried barrel height: 800mm Thickness: 6.0mm                                     |
| Lifting time: ≤3 seconds (adjustable fast 1 second)                              |
| Drive mode: compressed air drive                                                 |
| Protection class: IP68                                                           |
| Working temperature: -30°C ~ 55°C                                                |
| Drive voltage: DC24V                                                             |
| Warning signs: ultra-bright LED light and 3M reflective film                     |
| Control mode: PLC control system, wired desktop control, wireless remote control |
| Emergency function: equipped with EPS emergency power supply and one-key descent |



| Model: LZQZ-D1-JT02                                                              |
|----------------------------------------------------------------------------------|
| Column height: 600mm(can be customized)                                          |
| Cylinder diameter: 1st stage: 273mm, 2nd level: 219mm                            |
| Column thickness: 6mm (can be customized)                                        |
| Column material: 304# stainless steel seamless steel pipe                        |
| Ground flange: 304# stainless steel, thickness: 12.0mm                           |
| Buried barrel height: 470mm Thickness: 6.0mm                                     |
| Lifting time: ≤3 seconds (adjustable fast 1 second)                              |
| Drive mode: compressed air drive                                                 |
| Protection class: IP68                                                           |
| Working temperature: -30°C ~ 55°C                                                |
| Drive voltage: AC380V, AC220V, DC24V(customized)                                 |
| Warning signs: ultra-bright LED light and 3M reflective film                     |
| Control mode: PLC control system, wired desktop control, wireless remote control |
| Emergency function: equipped with EPS emergency power supply and one-key descent |



| Model: LZQZ-D1-JT03                                                              |
|----------------------------------------------------------------------------------|
| Column height: 690mm(can be customized)                                          |
| Cylinder diameter: 1st stage: 273mm, second stage: 219mm, third stage: 168mm     |
| Column thickness: 6mm (can be customized)                                        |
| Column material: 304# stainless steel seamless steel pipe                        |
| Ground flange: 304# stainless steel, thickness: 12.0mm                           |
| Buried barrel height: 400mm Thickness: 6.0mm                                     |
| Lifting time: 5-7 seconds                                                        |
| Drive mode: compressed air drive                                                 |
| Protection class: IP68                                                           |
| Working temperature: -30°C ~ 55°C                                                |
| Drive voltage: DC24V                                                             |
| Warning signs: ultra-bright LED light and 3M reflective film                     |
| Control mode: PLC control system, wired desktop control, wireless remote control |
| Emergency function: equipped with EPS emergency power supply and one-key descent |

# PNEUMATIC LIFTING BOLLARD INTELLIGENT CONTROL SYSTEM

Intelligent lifting bollard control system



Oil Free Silent Air Compressor 52(dB)

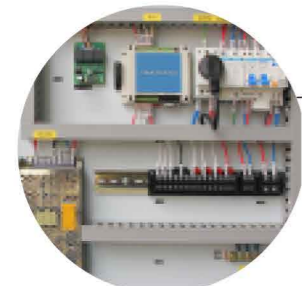

The internal layout is standardized, reasonable and beautiful; Electrical components are purchased from first-line high-quality brands



Technical Parameters

|                             |                                                                  |
|-----------------------------|------------------------------------------------------------------|
| Input voltage               | AC220V                                                           |
| Output voltage              | DC24V                                                            |
| Installation method         | Floor / wall-mounted indoor / outdoor                            |
| Degree of protection        | IP54                                                             |
| Material                    | Galvanized sheet                                                 |
| Control mode                | Remote control/mobile APP/remote control/other linkage equipment |
| Control the motherboard     | PLC                                                              |
| Mode of transmission        | 4G/5G/WIFI/LAN/WAN                                               |
| air compressor              | Oil Free Silent Air Compressor 52(dB)                            |
| Backup battery              | accumulator                                                      |
| Public security linkage     | Support                                                          |
| Power outage emergency drop | Support                                                          |
| Remote control              | Support                                                          |
| buzzer                      | Support                                                          |
| traffic light               | Support                                                          |
| Ground sense linkage        | Support                                                          |
| License plate recognition   | Support                                                          |

Intelligent lifting column wireless console

Technical Parameters



|                     |                                                                                                        |
|---------------------|--------------------------------------------------------------------------------------------------------|
| Control mode:       | wireless remote control, 315 MHz encryption                                                            |
| Control distance:   | ≥50m empty                                                                                             |
| Control the rise:   | down, and stop switches                                                                                |
| Encryption measures | Using frequency modulation, anti-interference, encrypto Ensure the security of the transmission signal |

Lifting column wired console

Technical Parameters

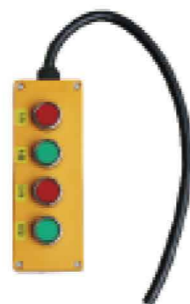

|                   |                         |
|-------------------|-------------------------|
| Control mode:     | Line empty              |
| Control distance: | ≥200m                   |
| Control the rise: | down, and stop switches |

# Schematic diagram of pneumatic lifting column installation

Installation requirements: Recommended distance between the center of the lifting column and the center of the lifting column is 800-1200mm (can also be customized according to customer needs)

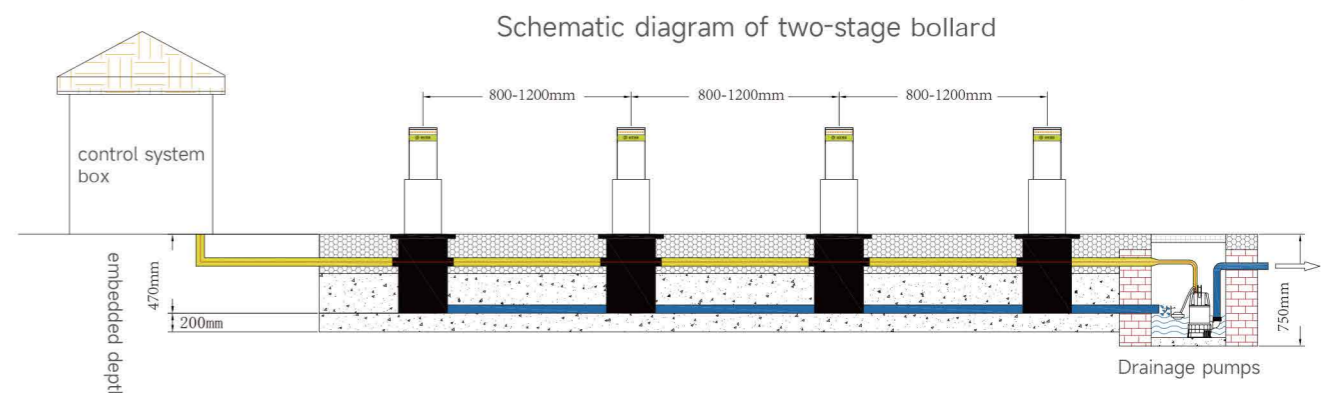
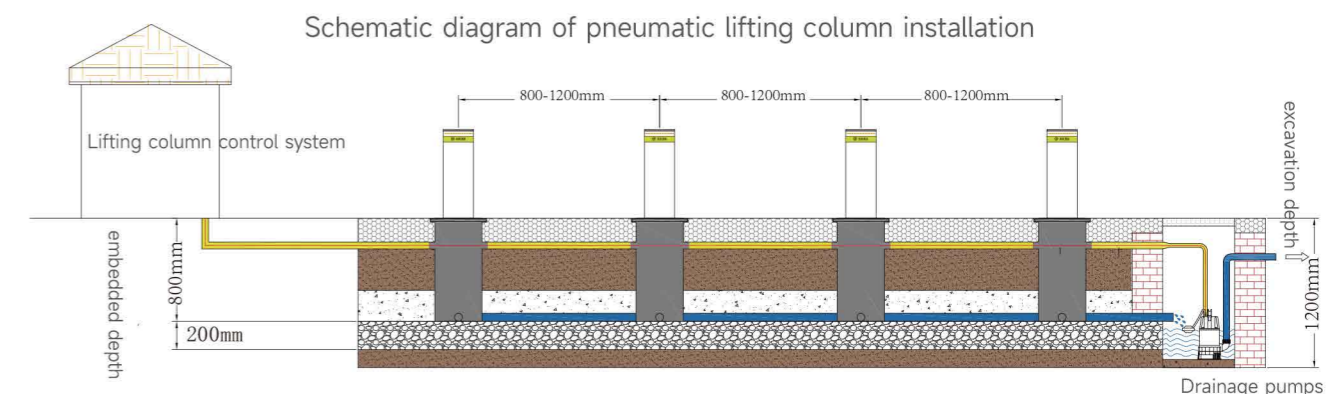

- Pavement
- Permeable Layer
- Concrete
- Cover
- Brick
- Wire Pipe
- Natural Soil
- Drain Pipe

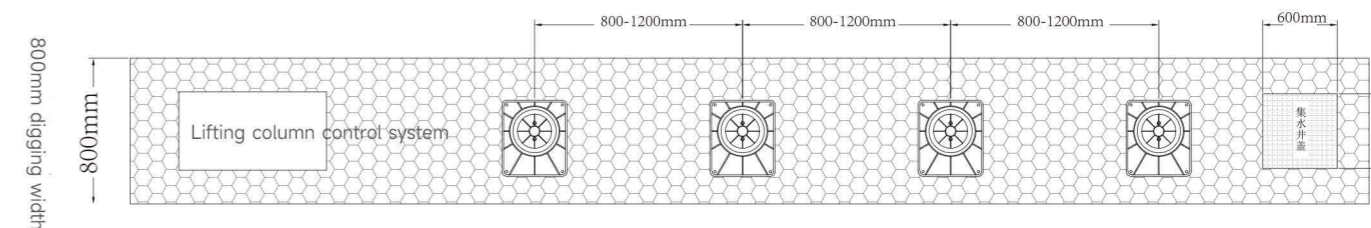

Connected to the municipal drainage system

# HYDRAULIC FLAP ROADBLOCKS



## Standard type/model: JT-LZJ-01

The hydraulic flap road blocker is divided into two types: reinforced type and standard type, which are mainly specialized for preventing unauthorized vehicles from forcibly entering sensitive areas. The door design and development have high practicality, reliability and safety.

The main body of the hydraulic flap road blocker is composed of: the main body (Q235 steel welding forming), hydraulic cylinder, hydraulic station system and PLC control system. It is composed of Q235 steel welding forming, hydraulic cylinder, hydraulic station system and PLC control system.



### 产品技术参数 Product Technical Parameters

|                                                                                                             |                                                                             |
|-------------------------------------------------------------------------------------------------------------|-----------------------------------------------------------------------------|
| Body material: Q235 steel plate                                                                             | Collision avoidance: 10T truck, 80 kilometers per hour can not be crossed.  |
| Plate thickness: 20mm (can be customized 16mm-30mm)                                                         | Passage pressure: can pass more than 120 tons of container trucks           |
| Lifting height: 600mm (customized 400mm-800mm)                                                              | Protection level: IP68                                                      |
| Interception width: standard 3000mm, 6000mm (customized 1000mm—8000mm)                                      | Color: standard yellow-black, red-yellow, other colors can be customized    |
| Drive form: hydraulic power source                                                                          | Lifting speed: 3-4 seconds                                                  |
| Temperature resistance: -40°C -70°C,                                                                        | Automatic thermostatic system Power supply mode: AC 380V                    |
| Control mode: wired platform control, wireless remote control, power failure can be emergency pressure drop | Total power: power unit 1.5KW-3.7KW (no power consumption in standby state) |
| Control distance: wireless control (barrier-free) 50 meters, wire control 100 meters                        |                                                                             |

# HYDRAULIC FLAP ROADBLOCKS

## 液压翻板路障机



# Reinforced type/model: JT-LZJ-02

Hydraulic flap road blocker is divided into two types: reinforced type and standard type, which are mainly specially designed for sensitive areas to prevent unauthorized vehicles from forcibly entering designed and developed, with high practicability, reliability and safety.

The main body of the hydraulic flap road blocker is composed of: the main body (Q235 steel welding forming), hydraulic cylinder, hydraulic station system and PLC control system

Compose. It is composed of Q235 steel welding forming, hydraulic cylinder, hydraulic station system and PLC control system.



### 产品技术参数 Product Technical Parameters

|                                                                                                             |                                                                             |
|-------------------------------------------------------------------------------------------------------------|-----------------------------------------------------------------------------|
| Body material: Q235 steel plate                                                                             | Collision avoidance: 10T truck, 80 kilometers per hour can not be crossed.  |
| Plate thickness: 20mm (can be customized 16mm-30mm)                                                         | Passage pressure: can pass more than 130 tons of container trucks           |
| Lifting height: 600mm (customized 400mm-800mm)                                                              | Protection level: IP68                                                      |
| Interception width: standard 3000mm, 6000mm (customized 1000mm-8000mm)                                      | Color: standard yellow-black, red-yellow, other colors can be customized    |
| Drive form: hydraulic power source                                                                          | Lifting speed: 3-4 seconds                                                  |
| Temperature resistance: -40°C -70°C,                                                                        | Automatic thermostatic system Power supply mode: AC 380V                    |
| Control mode: wired platform control, wireless remote control, power failure can be emergency pressure drop | Total power: power unit 1.5KW-3.7KW (no power consumption in standby state) |
| Control distance: wireless control (barrier-free) 50 meters, wire control 100 meters                        |                                                                             |

SINCE 2006 ENTERPRISE ALBUM 2023

JIETIAN TECHNOLOGY

## Standard type/model: JT-LZJ-01

Hydraulic flap road blocker is divided into two types: reinforced type and standard type, which are mainly specially designed for sensitive areas to prevent unauthorized vehicles from forcibly entering, special designed and developed, with high practicability, reliability and safety.

The main body of the hydraulic flap barricade machine is composed of: main body (Q235 steel welding forming), hydraulic cylinder, hydraulic station system and PLC control system group

Yes. It is composed of Q235 steel welding forming, hydraulic cylinder, hydraulic station system and PLC control system.



### 产品技术参数 Product Technical Parameters

|                                                                                                             |                                                                             |
|-------------------------------------------------------------------------------------------------------------|-----------------------------------------------------------------------------|
| Body material: Q235 steel plate                                                                             | Collision avoidance: 10T truck, 80 kilometers per hour can not be crossed.  |
| Plate thickness: 20mm (can be customized 16mm-30mm)                                                         | Passage pressure: can pass more than 100 tons of container trucks           |
| Lifting height: 600mm (customized 400mm-800mm)                                                              | Protection level: IP68                                                      |
| Interception width: standard 3000mm, 6000mm (customized 1000mm—8000mm)                                      | Color: standard yellow-black, red-yellow, other colors can be customized    |
| Drive form: hydraulic power source                                                                          | Lifting speed: 3-4 seconds                                                  |
| Temperature resistance: -40°C -70°C,                                                                        | Automatic thermostatic system Power supply mode: AC 380V                    |
| Control mode: wired platform control, wireless remote control, power failure can be emergency pressure drop | Total power: power unit 1.5KW-3.7KW (no power consumption in standby state) |
| Control distance: wireless control (barrier-free) 50 meters, wire control 100 meters                        |                                                                             |

## HYDRAULIC FLAP ROADBLOCKS

### 液压翻板路障机



# TIRE KILLER 破胎器

Three kinds tire killers; speed bump type tire killer, buried tire killer, buried two-way tire killer for selection.

The product adopts electromechanical integration, remote control or button control mode, with two functions of deceleration and tire killer, is to control vehicle speed, prevention illegal break-ins and barbaric vehicles break into posts, and security precautions are indispensable for ensuring the personal safety of others and the safety of state property. It is suitable for prisons, detention centers, oil depots, hydropower stations, liquefied gas stations and other places.



| Product Technical Parameters                                                              |                                                                           |                                                               |
|-------------------------------------------------------------------------------------------|---------------------------------------------------------------------------|---------------------------------------------------------------|
| Speed bump type: length (customizable), width 610mm, height 76mm                          | blade spacing: 125mm                                                      | Protection level: IP68                                        |
| Buried tire killer: length (1000mm-10000mm can be customized), width 420mm, height 150mm  | Movement form: electromechanical / hydraulic                              | Surface treatment: Painted (black and yellow, color optional) |
| Two-way tyre killer: length (1000mm—10000mm can be customized), width 850mm, height 150mm | Working environment: -40°C -70°C                                          | Power supply mode: AC220V 50Hz                                |
| Control box size: above-ground box: 500mm×500mm×550mm, buried box: 600mm×350mm×400mm      | Two kind lifting control: wired platform control, wireless remote control | Blade height: 110mm                                           |
| Body material: Q235 steel plate                                                           | Rising and falling time: 0.7-1.5 seconds                                  |                                                               |

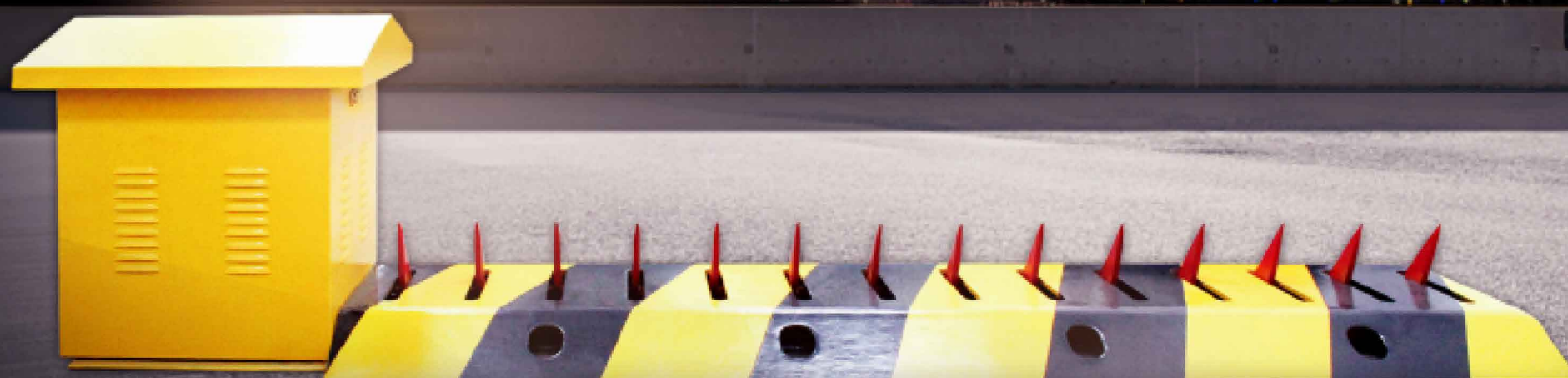

Speed Bump Type (Model: JT-PTQ-01)

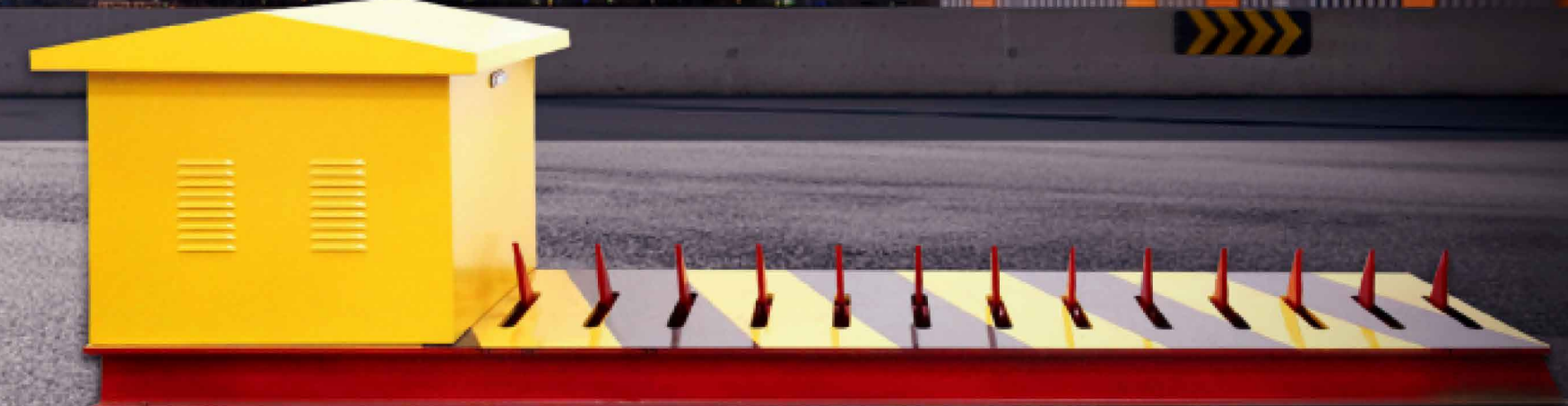

Buried One-way Tire killer (Model: JT-PTQ-02)

SINCE 2006 ENTERPRISE ALBUM 2023 JIETIAN TECHNOLOGY

# TIRE KILLER 破胎器

Three kinds tire killers; speed bump type tire killer, buried tire killer, buried two-way tire killer for selection.

the product adopts electromechanical integration, remote control or button control mode, with two functions of deceleration and tire killer, is to control vehicle speed, prevention illegal break-ins and barbaric vehicles break into posts, and security precautions are indispensable for ensuring the personal safety of others and the safety of state property. It is suitable for prisons, detention centers, oil depots, hydropower stations, liquefied gas stations and other places.



| Product Technical Parameters                                                              |                                                                           |                                                               |
|-------------------------------------------------------------------------------------------|---------------------------------------------------------------------------|---------------------------------------------------------------|
| Speed bump type: length (customizable), width 610mm, height 76mm                          | blade spacing: 125mm                                                      | Protection level: IP68                                        |
| Buried tire killer: length (1000mm-10000mm can be customized), width 420mm, height 150mm  | Movement form: electromechanical / hydraulic                              | Surface treatment: Painted (black and yellow, color optional) |
| Two-way tyre killer: length (1000mm—10000mm can be customized), width 850mm, height 150mm | Working environment: -40°C -70°C                                          | Power supply mode: AC220V 50Hz                                |
| Control box size: above-ground box: 500mm×500mm×550mm, buried box: 600mm×350mm×400mm      | Two kind lifting control: wired platform control, wireless remote control | Blade height: 110mm                                           |
| Body material: Q235 steel plate                                                           | Rising and falling time: 0.7-1.5 seconds                                  |                                                               |



Buried two-way tire killer(Model: JT-PTQ-03)

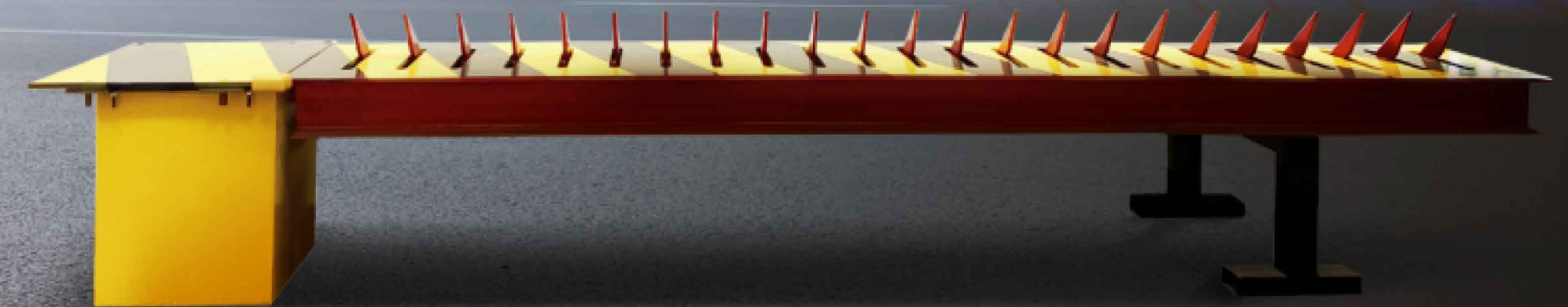

Underground box type tire killer(Model: JT-PTQ-05)

# PRODUCT MARKET DISTRIBUTION



Adhering to the corporate culture of "seeking truth and pursuing excellence", Jietian takes the business philosophy of continuous innovation as the guide, and focuses on delivering service value and customer service needs to customers. With Xiamen, Fujian as the center, in Beijing, Shanghai, Tianjin, Jiangsu, Guangzhou, Shenzhen, Heilongjiang, Henan, Zhengzhou, Hainan, Yunnan, Anhui, Inner Mongolia, and Chengdu, etc., more than 30 large and medium-sized cities across the country have distribution service providers, sales network and 400 call service system throughout the country.

Products are exported to Italy, Britain, Germany, Japan, Canada, Mid-east, and other parts of the world, enjoy a high reputation, serving more than 100,000 customers and establishing a nationwide service network. Perfect management mechanism, professional service team, to provide you with worry-free quality service

In the end, with the continuous development of mobile Internet and intelligent technology, we will focus on the interconnection of products and equipment, the deep mining and analysis of big data, and focus on the solution of "safety + smart travel, people-vehicles-life"..

To provide more convenient, safer and better quality products and services, we firmly believe that JIETIAN will be "modern science and technology, service affectionate, brand internationalization" enterprise, JIETIAN people are in line with the goal of building a world-renowned brand, providing first-class service unremitting efforts, willing to work with you to create a better tomorrow!



## Our mission

Safety is the top priority related to people's livelihood. Guarding a territory and keeping the people peaceful and harmonious is the goal I am committed to pursuing. Let our products withstand consideration, is the direction of every Jie Tian people's unremitting efforts!

## Our purpose

Never satisfied with standards, only by constantly breaking through barriers, can we know the unlimited potential of Jietian, the ideal of daring to be the first, stimulate our inner core strength, do a good job of anti-collision roadblocks, so that life has less danger and more warmth!

## After-sales commitment

Every need of customers is motivating us to do the ultimate, do not pursue vanity and gorgeousness, we only use solid products to serve customers, Jie Tian people to integrity and sincerity, only to deliver positive energy to the society!

In the spirit of quality, efficiency and development, the company is committed to "quality first, service first" and strives to provide customers with quality services and strive to satisfy customers.

Resolutely implement the service policy of "24 hours of uninterrupted service day and night, 365 days without holidays". Solve the problems of the use of the product during the after-sales service in a timely manner.

In line with the business tenet of "providing customers with the most satisfactory products and services", the company solemnly promises: while ensuring the advanced, reliable and stable equipment, we will continuously improve the service quality to ensure that customers can get the best service, so that customers are satisfied and assured.

### Pre-sales service

Party A's project approval to the project signing, our company's services before the signing of the project contract

1. meters provides the most advanced, reasonable and mature system structure;
2. Consider the sustainability of the product system;
3. Clear and reasonable system device requirements;
4. Provide targeted design and system quotation.



### In-sale service

After the signing of the contract by both parties A and B, the completion and acceptance, the services provided

1. Construction organization plan;
2. Establishment of construction, installation and acceptance files of the project;
3. System training for users;



### After-sales service

Party A's project approval to the project signing, our company's services before the signing of the project contract

- 1 . Provide one-year warranty and permanent repair service for products;
- 2 . Customized maintenance and maintenance guidance system for each customer;
- 3 . Documented management of your installed systems.



After-sales service telephone: +86 18259496896

After-sales service Email: sinna@cnjietian.com